

HIGH SPEED SMT MAGNETIC MODULES FOR 10/100BASE-TX APPLICATIONS

- MEETS OPEN CIRCUIT INDUCTANCE (OCL) SPECIFICATIONS OF 350uH MIN WITH 8mA DC BIAS FROM 0-70°C
- DESIGNS AVAILABLE FOR ALL 10/100BASE-TX PHY CHIPS
- CUSTOM DESIGNS AVAILABLE INCLUDING THROUGH HOLE AND COMBOS

Electrical Specifications:

Part Number	Turns Ration (+/-5%)		Insertion Loss 100KHz-100MHz (dB TYP)	Return Loss (dB TYP)			Crosstalk (dB MAX)			Hipot (Vrms MIN)
	Receive	Transmit		30 MHz	60 MHz	80 MHz	32 MHz	62 MHz	100 MHz	
XF6611TX	1CT:1CT	1.25CT:1CT	-1.0	-16	-12	-10	-40	-35	-35	1500
XF6611TX1	1CT:1CT	1.25CT:1CT	-1.0	-16	-12	-10	-40	-35	-35	1500
XF6611TX2	1CT:1CT	1.25CT:1CT	-1.0	-16	-12	-10	-40	-35	-35	1500
XF6612TX	1CT:1CT	1.41CT:1CT	-1.0	-16	-12	-10	-40	-35	-35	1500
XF6612TX1	1CT:1CT	1.41CT:1CT	-1.0	-16	-12	-10	-40	-35	-35	1500
XF6612TX2	1CT:1CT	1.41CT:1CT	-1.0	-16	-12	-10	-40	-35	-35	1500
XF6692TX	1:1:1	2CT:1	-1.0	-15	-15	-15	-40	-40	-40	1500
XF6692TX1	1:1:1	2CT:1	-1.0	-15	-15	-15	-40	-40	-40	1500
XF6694TX	1:1:1CT	2CT:1CT	-1.0	-15	-15	-15	-40	-40	-40	1500
XF6694TX2	1:1	1:2CT	-1.0	-15	-15	-15	-40	-40	-40	1500

Dimensions:

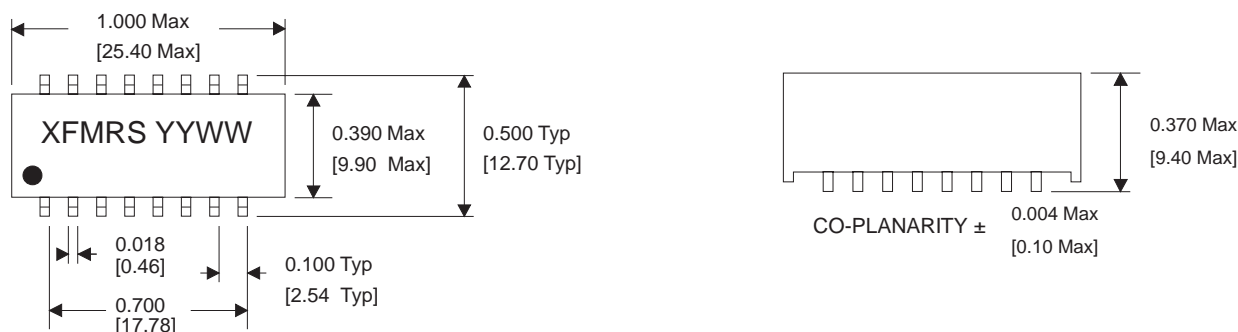

Schematics:

SEE FOLLOWING PAGE

HIGH SPEED SMT MAGNETIC MODULES FOR 10/100BASE-TX APPLICATIONS

Schematics:

XF6611TX

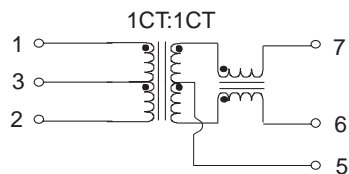
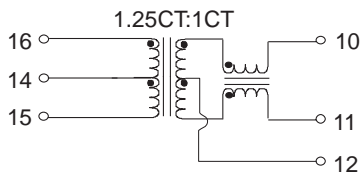

XF6612TX

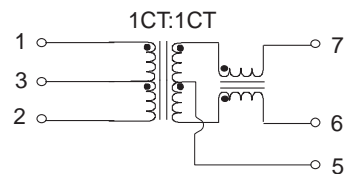
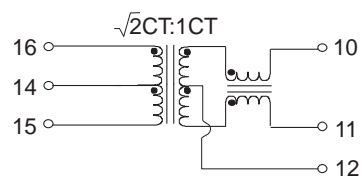

XF6611TX1

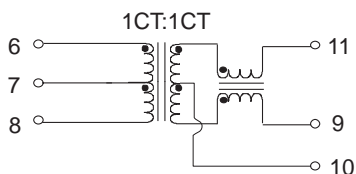
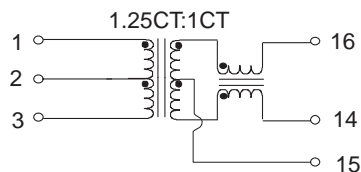

XF6612TX1

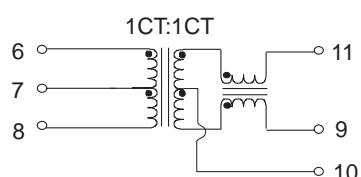
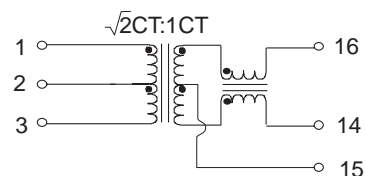

XF6611TX2

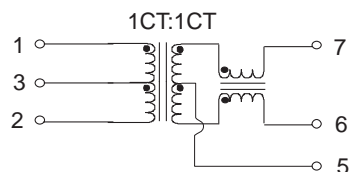
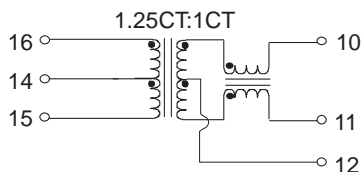

XF6612TX2

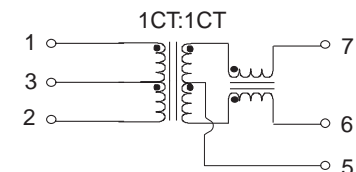
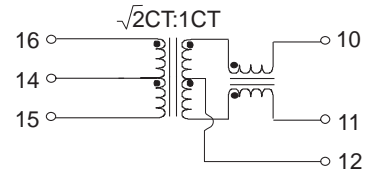

HIGH SPEED SMT MAGNETIC MODULES FOR 10/100BASE-TX APPLICATIONS

Schematics:

XF6692TX

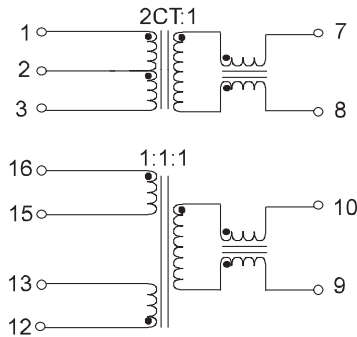

XF6694TX

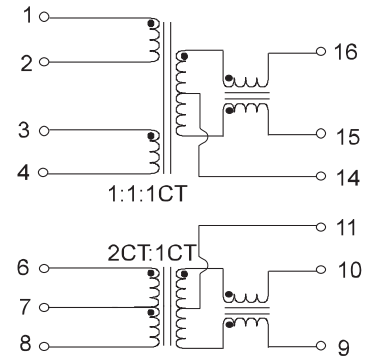

XF6692TX1

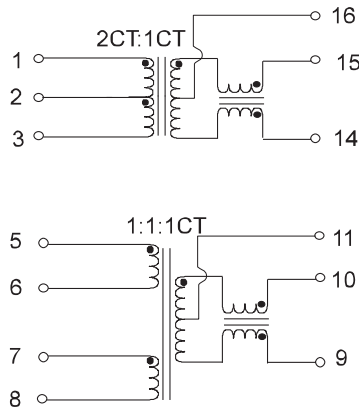

XF6694TX2

